

WARATAH[®]

EQUINE FENCING CATALOGUE



Visit waratahfencing.com.au or phone 13 10 80



WARATAH EQUINE SYSTEMS

Waratah offer versatile and effective equine systems designed to make fencing for horses safer, easier, and more cost effective over the life of your fence.

Waratah's posts, wire, Flex Rail™ and accessories take the guess work out of choosing the right products for your equine fencing. Designed to work together, Waratah products offer versatility when it comes to choosing the right fence for your equine needs. From Longlife Blue® netting for foaling yards to electric Flex Rail™ for larger paddocks, Waratah have equine systems to suit a range of horse fencing applications.

This publication contains general information on Waratah's equine range as well as Waratah's Flex Rail systems, including sample fence designs to provide safe and effective fencing for your horses. Performance of the products will depend on many factors including soil types, animal pressure, number of horses and location.



POSTS

The key to a fence's strength and longevity, Waratah posts are the superior quality backbone to a better performing fence.

- › Waratah JiO® posts are designed to work seamlessly with the range of Flex Rail™, wire & accessories for superior performance & fence visibility.
- › Effective strainer post assemblies help improve the life of your fence by carrying the strain of the wire and absorbing impact from animals.
- › Challenge your traditional fencing practices to discover the benefits of the complete Waratah equine system.



EZYPIPE® STRAINER POST

The Waratah round post alternative to traditional timber, pipe and concrete strainer posts.

- > Best suited to medium-soft ground applications where the greater surface area and anchor points provide improved ground-holding capacity.
- > Economical to erect and capable of withstanding high pressure loads.
- > Termite proof and fire resistant.
- > Can be stayed up to 4 ways through 360 degrees and is also suitable as an in-line strainer.
- > Hot dipped galvanized coating (min 300g/m²) for good corrosion protection.
- > Ezypipe strainer extensions can be used with an Ezypipe strainer post to increase fence height.
- > Anchor points on the strainer allow for Star® posts to be driven through as an anchor pin to provide greater holding capacity.
- > Gate fittings also available.

SPECIFICATIONS

Pipe:	89mm (OD) x 4mm (wall)
Material:	250 grade pipe
Coating:	Hot dipped galvanized (min 300g/m ²)
Lengths available:	2.15m, 2.50m, 3.25m



ADJUSTA-STAY®

One of the most versatile stays on the market. Can be used with the Ezyslot®, Ezypipe® and most timber, concrete or pipe strainer posts.

- > Fully adjustable and reusable stay (sold as a kit, see specifications).
- > Effective in all types of terrain including sloping, hard or rocky ground.
- > Termite proof and fire resistant.
- > Designed for strength, reliability and ease of use.
- > Requires no digging and can be installed in less than five minutes with correct tools (optional Adjusta-stay tube socket available).
- > Plastic ground engaging pad.

SPECIFICATIONS

Pipe:	50NB pipe x 60.3mm (OD) x 2.30mm (wall) x 3m length
Coating:	Hot dipped galvanized (min 300g/m ²)
Hot dipped tension rod length:	3.25m x M12 (12mm) with nuts and washers
Ground engaging pad:	Plastic 100% recycled 



See how quick and easy it is to install!



SUGGESTED STRAINER POST INSTALLATION HEIGHT

POST	ABOVE GROUND (MM)	IN GROUND (MM)
Ezypipe 2.15m	1300	850
Ezypipe 2.50m*	1400 -1600	900 -1100
Ezypipe 3.25m	2050	1200

*Adjustable collar locations using pre-drilled holes - collar comes pre-set at 2nd hole (1500mm above ground), but can be adjusted to 1400mm or 1600mm above ground.

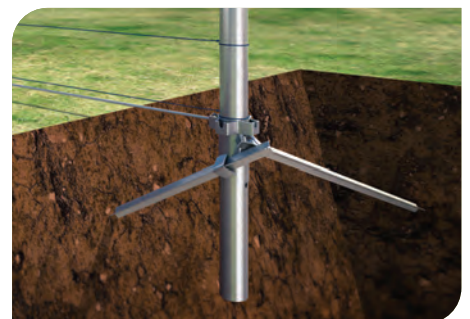



JiO® STAR®

- > The original Y shape fence post, Waratah's most reliable fence post product.
- > The strongest, toughest, most flexible Waratah Star post ever made.
- > Multiple attachment points
- > JiO clip available for easy wire to post attachment.
- > Lengths available: 135cm, 150cm, 165cm, 180cm, 210cm, 225cm, 240cm and 270cm.



JiO® MAXY®

- > The JiO MaxY post is twice as strong and double the profile of the JiO Star post for improved ground holding and performance.
- > Great intermediate post option compared to timber, concrete or pipe.
- > Lengths available: 180cm, 210cm, 240cm and 270cm.

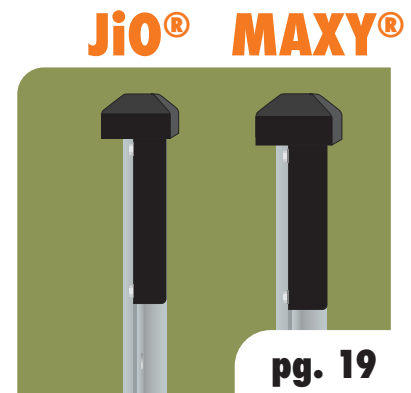

FLEX RAIL STAR POST CAP

- > Turn your star posts into a equine fencing solution with Waratah's Flex Rail™ star post caps. Available in black or white.

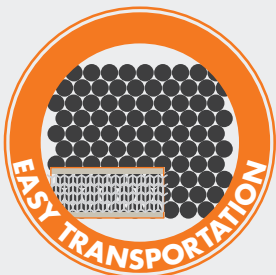

Easier transportation compared to timber, concrete and pipe



Easy installation with a manual or pneumatic driver



Termite proof & fire resistant



Tried and tested in the lab and field

POST SIZE AND HOLE ALIGNMENT GUIDE

The measurements below show that the first hole from the top of the post is 2.30cm. The measurement then shows distance between holes. The 5.08cm distance is to accommodate the use of JiO® post clips.

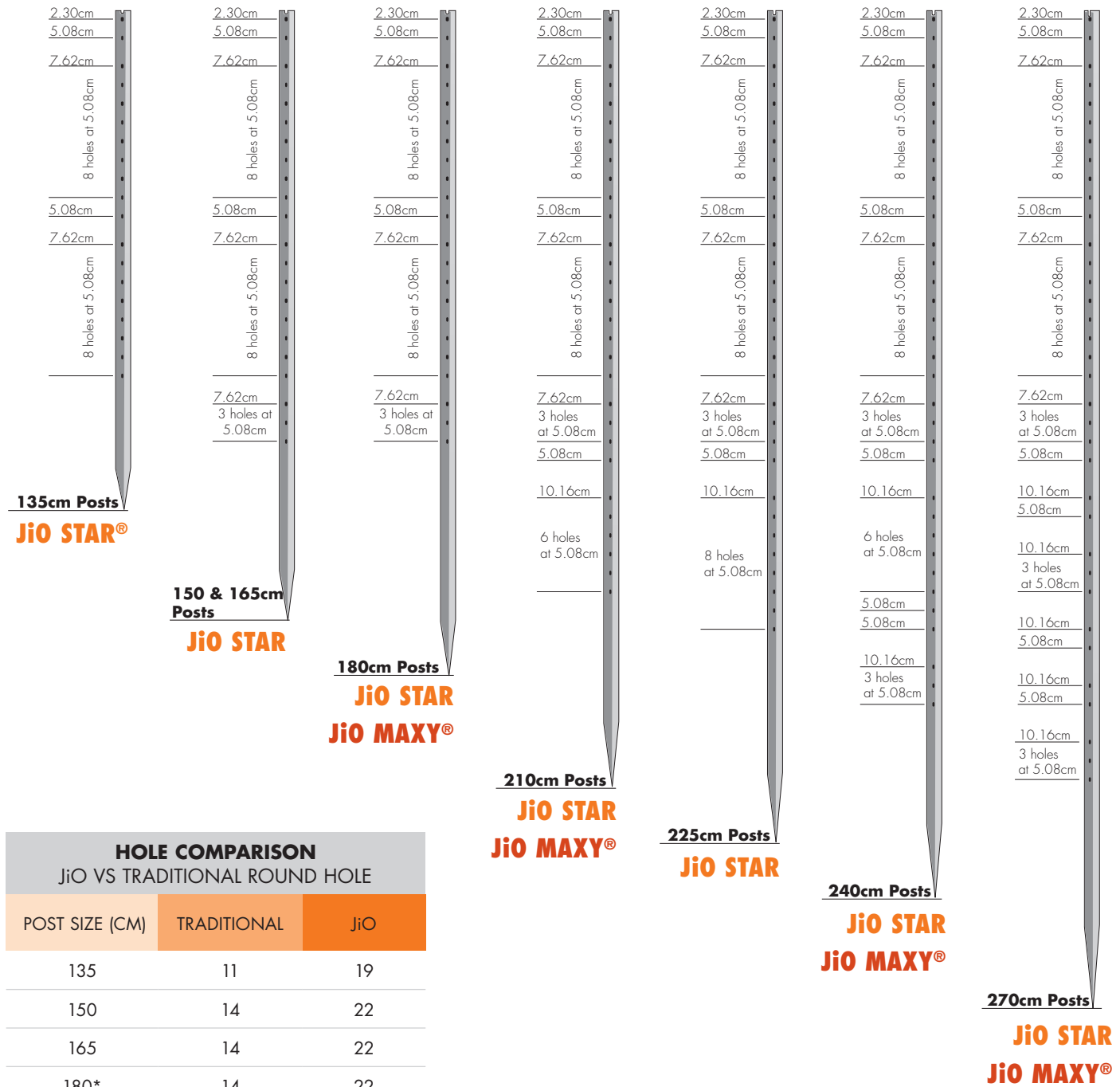

HOLE COMPARISON		
JiO VS TRADITIONAL ROUND HOLE		
POST SIZE (CM)	TRADITIONAL	JiO
135	11	19
150	14	22
165	14	22
180*	14	22
210*	17	29
225	17	31
240*	17	34
270*	-	35

*JiO MaxY post is only available in these sizes



WIRE

- › **Quality wire is essential for the life and performance of your fence.**
- › **Longlife Blue® fence wire uses innovative technology exclusive to Waratah®.**
- › **Longlife Blue® is a high-performance product that's been tried and tested to last as part of a complete Waratah fencing system.**



IF IT'S NOT BLUE, IT'S NOT WARATAH®!

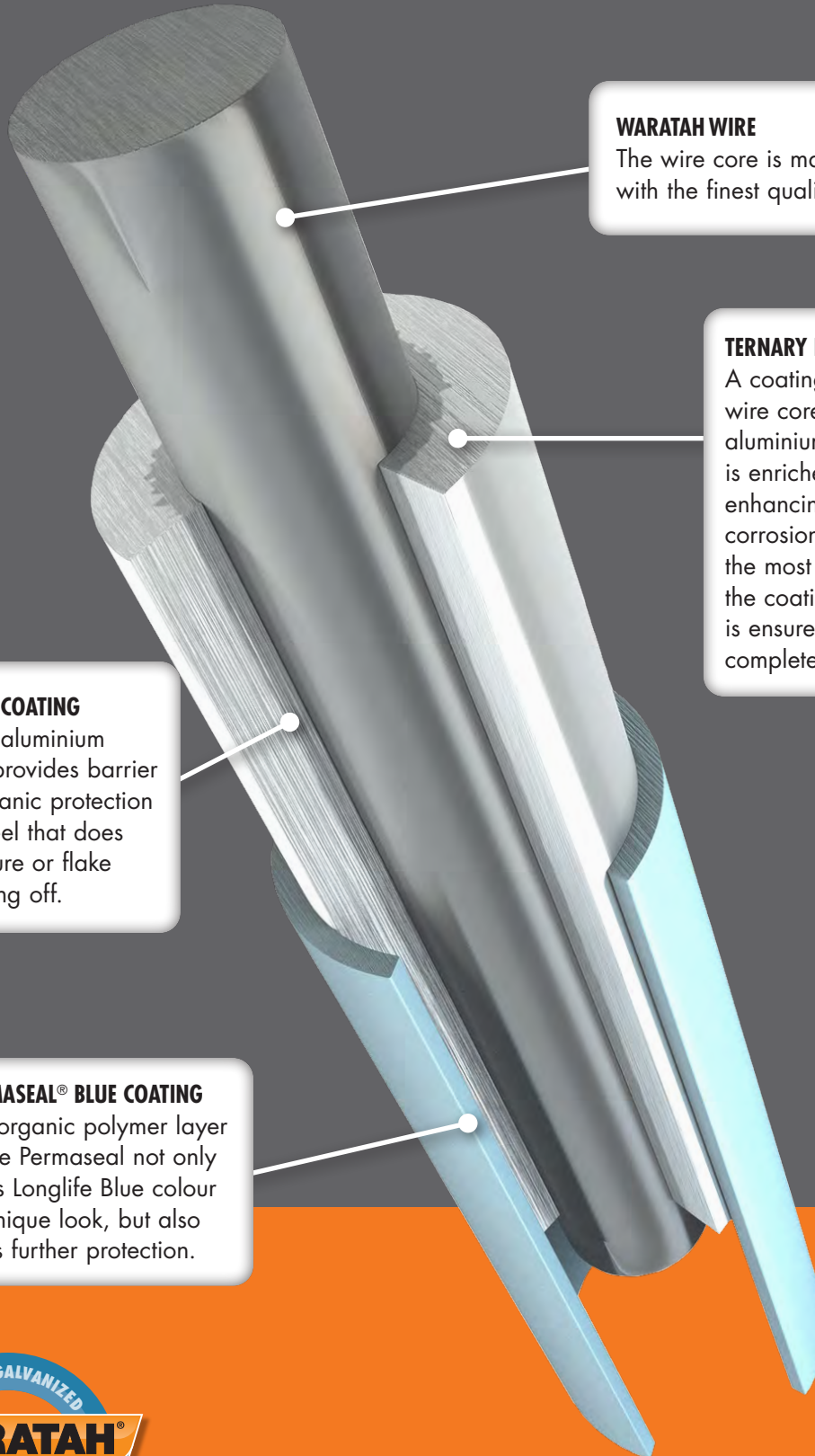

WARATAH WIRE

The wire core is made with the finest quality steel.

TERNARY LAYER

A coating layer closest to the wire core comprising of zinc/aluminium/iron. This layer is enriched in aluminium – enhancing both ductility and corrosion protection. This is the most important layer for the coating performance and is ensured to be “intact” and complete all around the wire.

ZALCOTE® COATING

The zinc aluminium coating provides barrier and galvanic protection of the steel that does not fracture or flake when tying off.

PERMASEAL® BLUE COATING

The organic polymer layer of the Permaseal not only gives Longlife Blue colour its unique look, but also adds further protection.





FLEXABEL® LONGLIFE BLUE MEDIUM TENSILE

- > For use in low to medium pressure situations.
- > General purpose wire is suited to electric fencing as it has good tying properties.

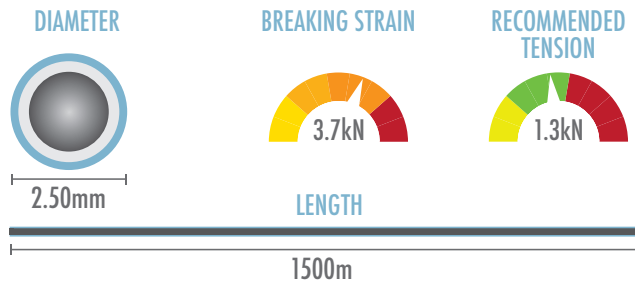

PERMELEC® LONGLIFE BLUE

- > Strong and flexible medium tensile wire specifically for permanent electric fencing.
- > Useful for situations such as cattle subdivision, strip grazing and to enhance existing fences.

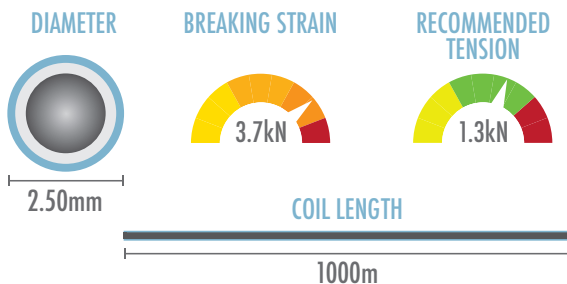

HORSESIGHTER® WIRE

- > UV stabilised PVC coated wire.
- > Has finished size of 5.20mm enclosing a low tensile 4.00mm standard galvanized wire.
- > White coating provides improved visibility for horses - perfect for use as a top wire with Stocksafe-T® Longlife Blue® 13/122.5/5 horse wire.

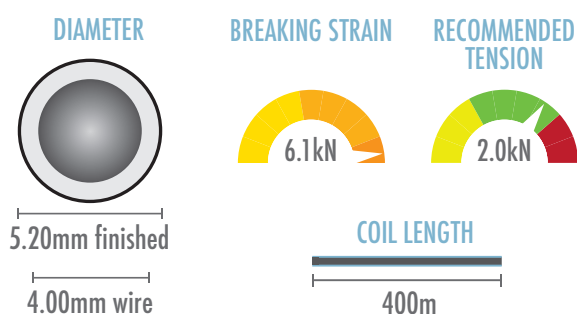

POSTS

3-6

WIRE

7-11

FLEX RAIL

12-21

ACCESSORIES 22-27



STOCKSAFE-T LONGLIFE BLUE® FOR HORSES, DOGS & HOUSE YARDS

Designed to keep horses and dogs secured in a yard.

- > Made from low tensile (soft) 3.15mm top and bottom line wires and 2.50mm line and picket wires, it has good stretch under stock pressure and is manufactured without sharp edges on wire, reducing injury to valuable stock.
- > Ensures the hooves of horses are not entangled and causing injury.
- > Low-tensile wire is favoured to reduce potential injury to horses.
- > Tight 5cm picket spacings reduce the risk of pawing, stepping or walking down the fence.

WIRE SIZE	SUGGESTED APPLICATION	ROLL LENGTH (M)
13/122.5/5	equine, dogs & house yards	50





NETTING LONGLIFE BLUE®

The range is designed for a wide variety of applications.

- › Typically used in foaling yards with the smaller mesh spacings protecting against leg breaking/ injury. Also can be used for exclusion applications.
- › Netting pattern is produced in reverse twist to better absorb impact.
- › Two-ply selvedge wire is used to give the netting added strength.
- › For light pressure applications the 1.4mm wire is most suitable, for heavy use high pressure applications or in highly corrosive environments the 1.8mm wire is better suited.
- › For tighter exclusion applications the 3cm mesh spacing is recommended to prevent smaller animals such as kittens (baby rabbits) from getting through the fence. Commonly used at ground level.

WIRE SIZE*	ROLL LENGTH (M)	WIRE SIZE*	ROLL LENGTH (M)
4.0cm MESH	1.4mm	3.0cm MESH	1.4mm
30/4.0/1.40	100	30/3.0/1.40	100
60/4.0/1.40	100	60/3.0/1.40	100
90/4.0/1.40	50, 100	90/3.0/1.40	50, 100
105/4.0/1.40	50, 100	105/3.0/1.40	50, 100
180/4.0/1.40	50	120/3.0/1.40	50, 100

4.0cm MESH	1.8mm	5.0cm MESH [^]	1.6mm
30/4.0/1.80	100	90/5.0/1.60	50
60/4.0/1.80	100	120/5.0/1.60	50
90/4.0/1.80	50, 100	180/5.0/1.60	50
105/4.0/1.80	50, 100		
180/4.0/1.80	50		

*30/4.0/1.40: 30cm fence height; 4cm mesh spacings; 1.40mm wire diameter.

[^]recommended for poultry mesh applications.





WARATAH FLEX RAIL SYSTEM



LOW
MAINTENANCE



LOOKS
GREAT



ADDED
STRENGTH



SAFE



UV RESISTANT



ELECTRIFIABLE



BACKED BY
WARATAH
GUARANTEE



AUSTRALIAN
MADE



RAIL

The Waratah Flex Rail™ system is designed to make fencing for horses safer, easier, and more cost effective over the life of your fence.

Closely resembling traditional timber rail fencing the Waratah Flex Rail™ system offers a simple solution for containing horses safely, without sacrificing appearance. Electric and non-electric systems available to suit a wide range of horse fencing applications. Backed by the Waratah Guarantee, you can be sure it's made for Australian conditions.



FLEX RAIL™ ELECTRIC ⚡



Waratah Flex Rail™ Electric offers a safe and effective alternative to traditional timber fencing. Waratah Flex Rail Electric is made using UV stabilised polymer, bonded with a highly conductive carbon compound. Delivering superior electrical conductivity along the length of the fence line.

Featuring two 2.50mm high tensile Longlife Blue® wires reinforcing the strength and breaking strain of the rail whilst also delivering maximum corrosion protection.

The high quality UV stabilised polymer rail is 120mm wide and is available in 150mtr rolls making it easy to handle and highly visible for horses safety.

RAIL COLOUR	RAIL WIDTH (MM)	ROLL LENGTH (M)	WIRE SIZE (MM)
BLACK	120MM	150M	2.50MM
WHITE	120MM	150M	2.50MM





POSTS

3-6

WIRE

7-11

FLEX RAIL

12-21

ACCESSORIES

22-27



IN-LINE SIDE BRACKET ⚡

- › Heavy duty plastic side bracket for attaching and insulating Flex Rail Electric to the side of the line post.
- › Use with Flex Rail Electric.
- › Available in black or white.
- › Bracket suitable for 120mm wide Flex Rail.
- › 50mm Tek screws provided.



IN-LINE TOP BRACKET ⚡

- › Heavy duty plastic top bracket for attaching and insulating Flex Rail Electric to the top of the line post.
- › Use with Flex Rail Electric.
- › Available in black or white.
- › Bracket suitable for 120mm wide Flex Rail.
- › 50mm Tek screws provided.



CORNER SIDE BRACKET ⚡

- › Heavy duty powder coated steel corner bracket.
- › Insulated for use with Flex Rail Electric.
- › Allows the rail to run continuously around corners and curves.
- › Ideal for round, square, steel or timber posts.
- › Available in black or white.
- › Bracket suitable for 120mm wide Flex Rail.

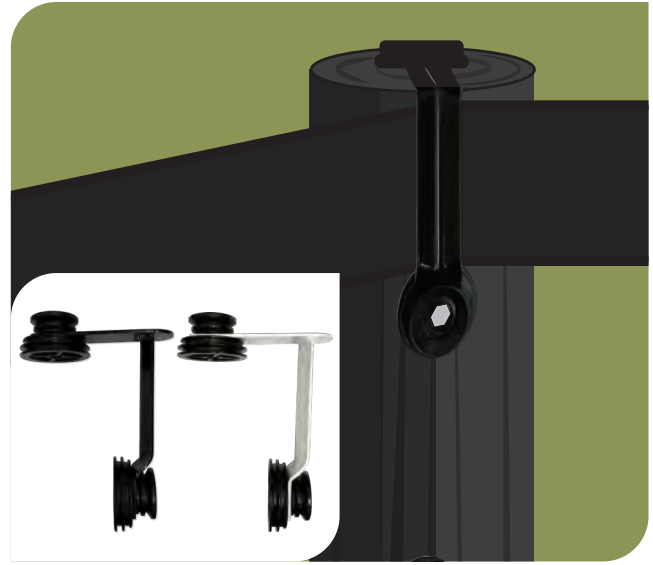

CORNER TOP BRACKET ⚡

- › Heavy duty powder coated steel top rail corner bracket.
- › Insulated for use with Flex Rail Electric.
- › Allows the rail to run continuously around corners and curves.
- › Ideal for round, square, steel or timber posts.
- › Available in black or white.
- › Bracket suitable for 120mm wide Flex Rail.



END FLAT BRACKET ⚡

- › Heavy duty powder coated steel end bracket.
- › Insulated for use with Flex Rail Electric.
- › Ideal for round, square, steel or timber posts.
- › Available in black or white.
- › Bracket suitable for 120mm wide Flex Rail.

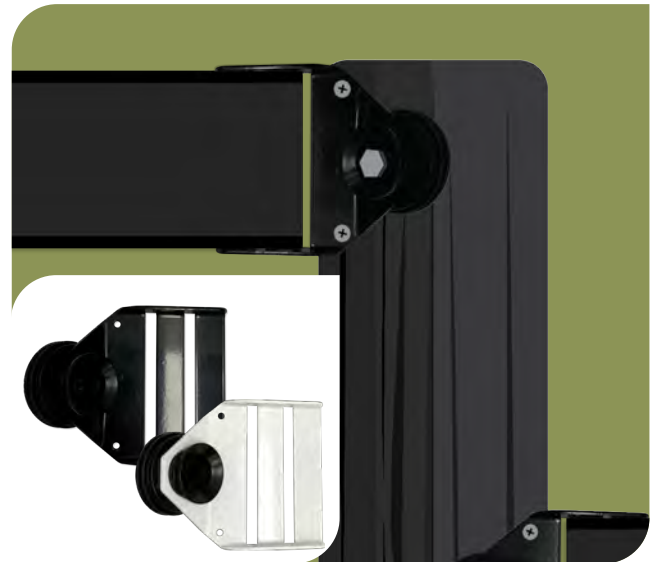

END ANGLE BRACKET ⚡

- › Heavy duty powder coated steel end angle bracket.
- › 45 degree end bracket for use on larger diameter steel/timber strainer posts.
- › Insulated for use with Flex Rail Electric.
- › Ideal for round, square, steel or timber posts.
- › Available in black or white & suitable for 120mm wide Flex Rail.

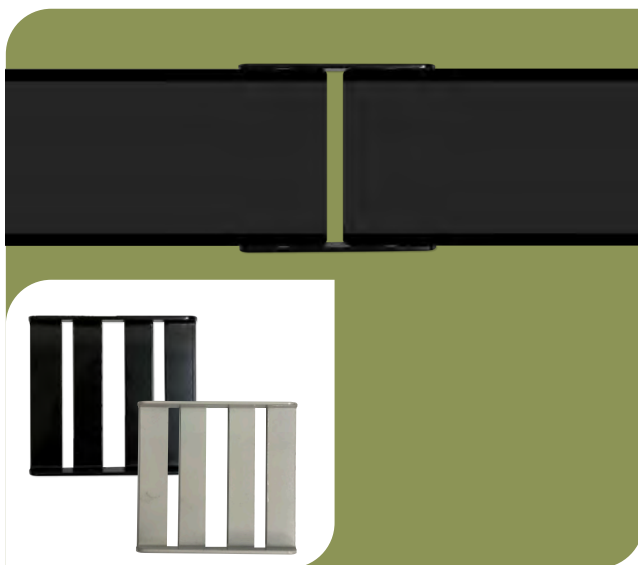

JOINER BRACKET ⚡

- › Heavy duty powder coated steel joiner bracket.
- › Suitable for joining two rolls of Flex Rail Electric.
- › Available in black or white.
- › Bracket suitable for 120mm wide Flex Rail.



TENSION SPOOL ⚡

- › Heavy duty powder coated tension spool.
- › For easy tensioning of Flex Rail.
- › Available in black or white.
- › Spool suitable for 120mm wide Flex Rail.



FLEX RAIL™



Waratah Flex Rail™ offers a safe and effective high quality UV stabilised polymer rail alternative to traditional timber rail fences.

Featuring two 2.50mm high tensile Longlife Blue® wires reinforcing the strength and breaking strain of the rail whilst also delivering maximum corrosion protection.

The high quality polymer rail is 120mm wide and is available in 100mtr rolls making it easy to handle and highly visible for horses safety.

RAIL COLOUR	RAIL WIDTH (MM)	ROLL LENGTH (M)	WIRE SIZE (MM)
BLACK	120MM	100M	2.50MM
WHITE	120MM	100M	2.50MM



POSTS

3-6

WIRE

7-11

FLEX RAIL

12-21

ACCESSORIES 22-27





TOP RAIL BRACKET

- › Designed to attach Flex Rail flush against the top of a line post.
- › Powder coated for corrosion protection.
- › Available in black or white.
- › Bracket suitable for 120mm wide Flex Rail.



STANDARD RAIL BRACKET

- › Allows lateral movement of the rail when impacted for greater absorption of impact, providing safe containment areas.
- › Powder coated for corrosion protection.
- › Available in black or white.
- › Bracket suitable for 120mm wide Flex Rail.

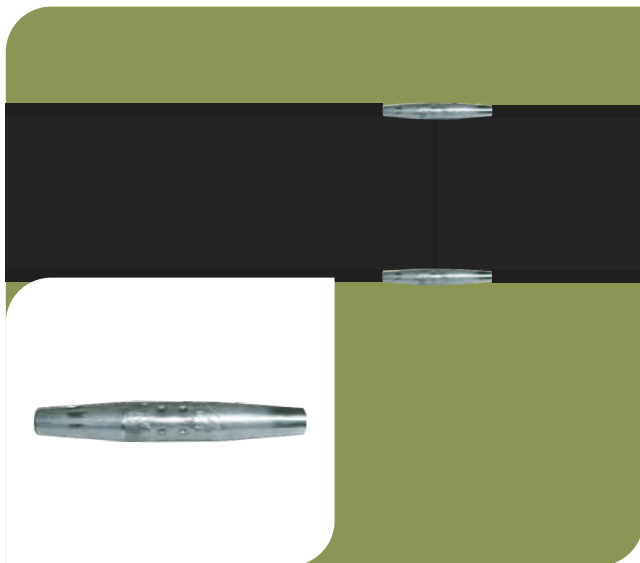

FLEX RAIL™ JOINER

- › Sleek wire joiner for joining Flex Rail.
- › Smooth edges ensures a safe joining point.
- › Suitable to use with 2.00mm - 3.15mm wire.



GRIPPLE® TL-300

- › Simple wire termination at strainer post.
- › Low profile design allows a safe and secure tension device suitable for equine fencing.
- › Eliminate the need for conventional tie-off knots around a strainer post.
- › Suitable for use with 2.00mm - 3.15mm wire.



POSTS

3-6

WIRE

7-11

FLEX RAIL

12-21

ACCESSORIES

22-27



FLEX RAIL STAR POST CAP

- > Heavy duty powder coated steel Star® post cap.
- > Use to safely install Flex Rail on JiO® Star posts.
- > Available in black or white.
- > Flex Rail electric in-line side bracket sold separately.



FLEX RAIL MAXY POST CAP

- > Heavy duty powder coated steel MaxY® post cap.
- > Use to safely install Flex Rail on JiO® MaxY posts.
- > Available in black or white.
- > Flex Rail electric in-line side bracket sold separately.

COMMON FLEX RAIL FENCE DESIGNS

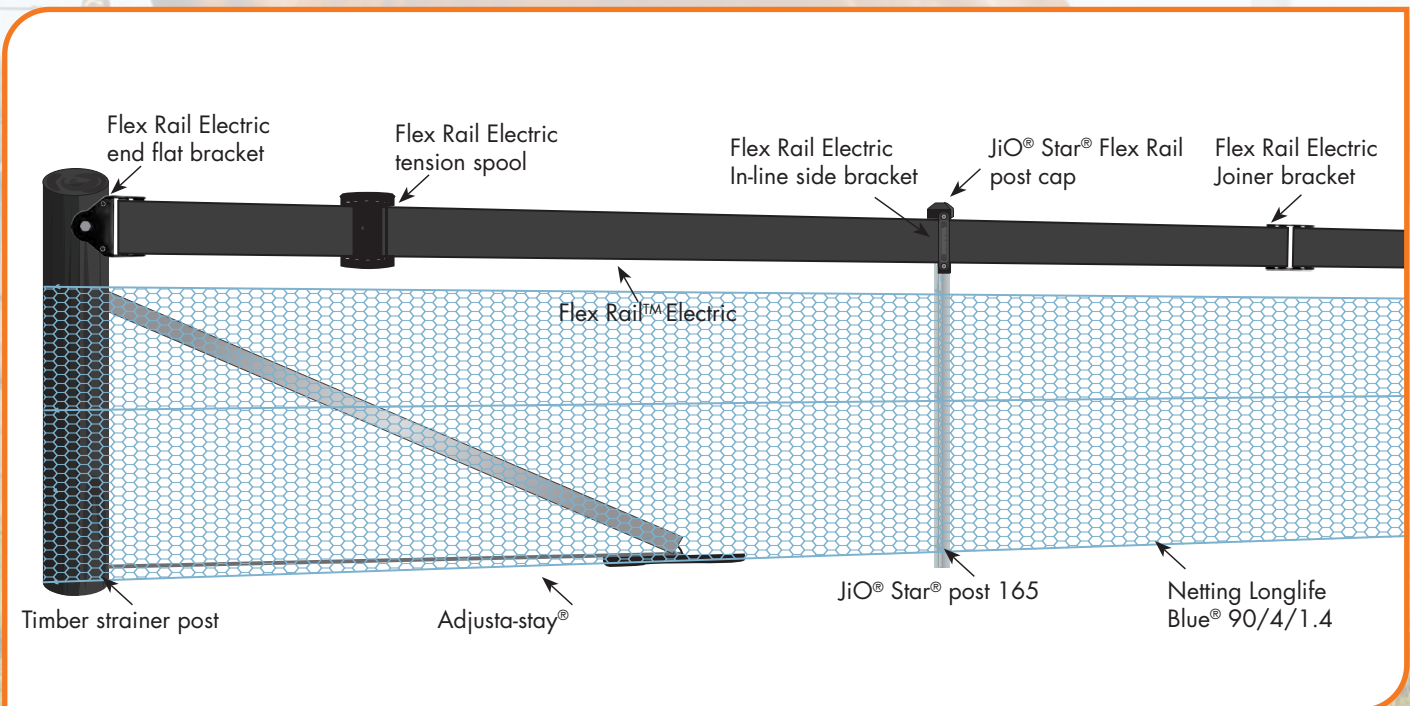

JiO® POST FLEX RAIL & NETTING FENCE DESIGN

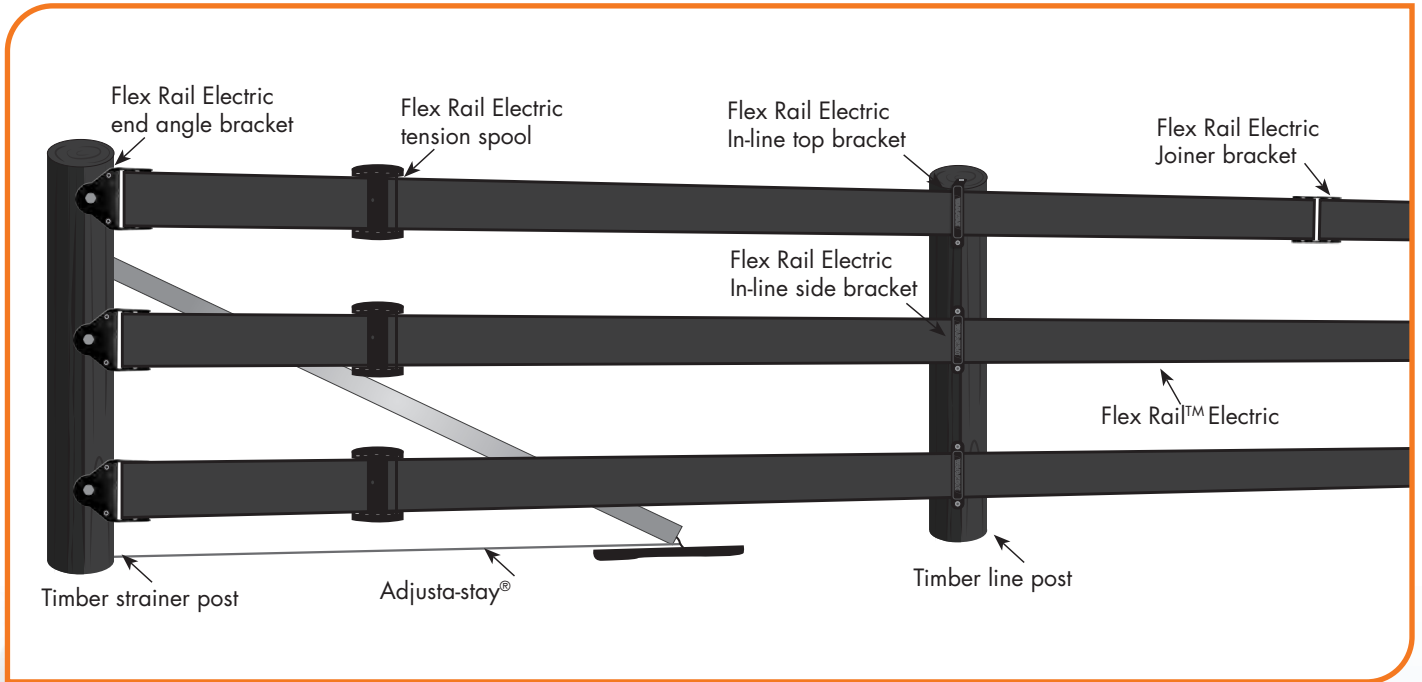

3 FLEX RAIL ELECTRIC HORSE FENCE

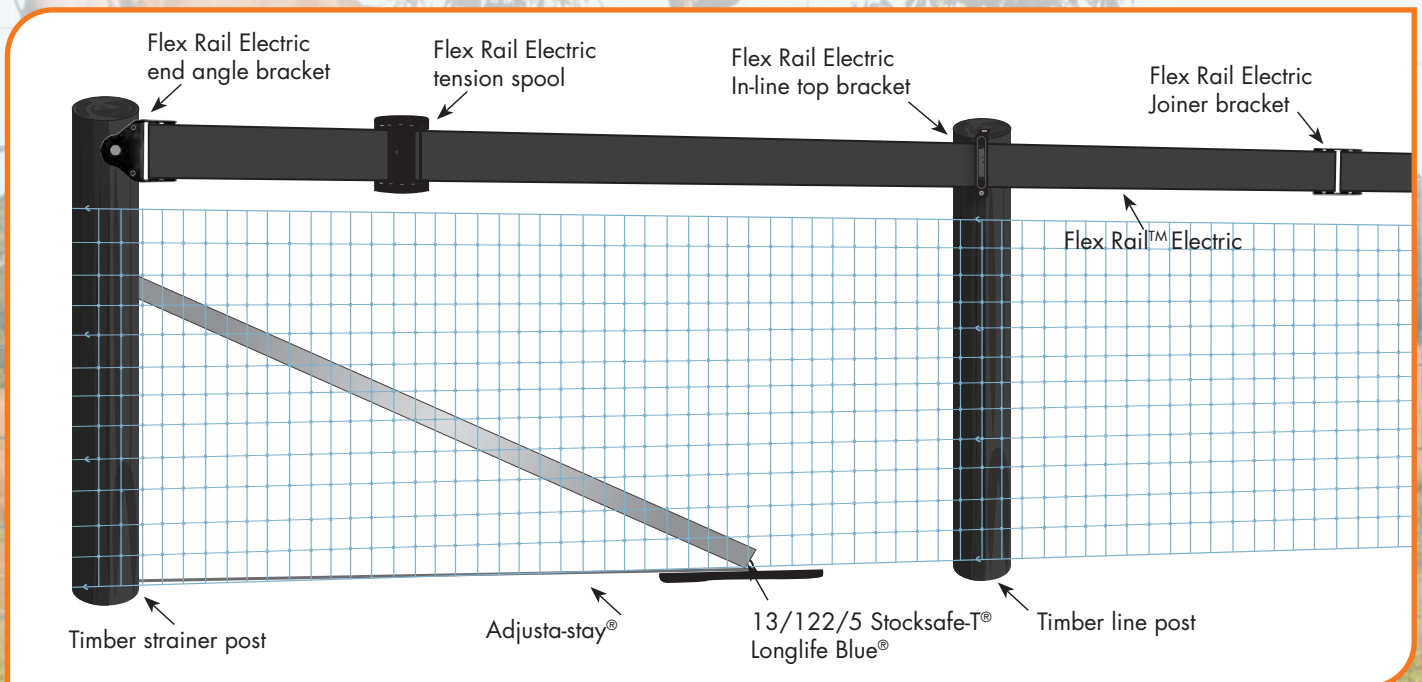

FLEX RAIL ELECTRIC HORSE FENCE WITH STOCKSAFE-T LONGLIFE BLUE®

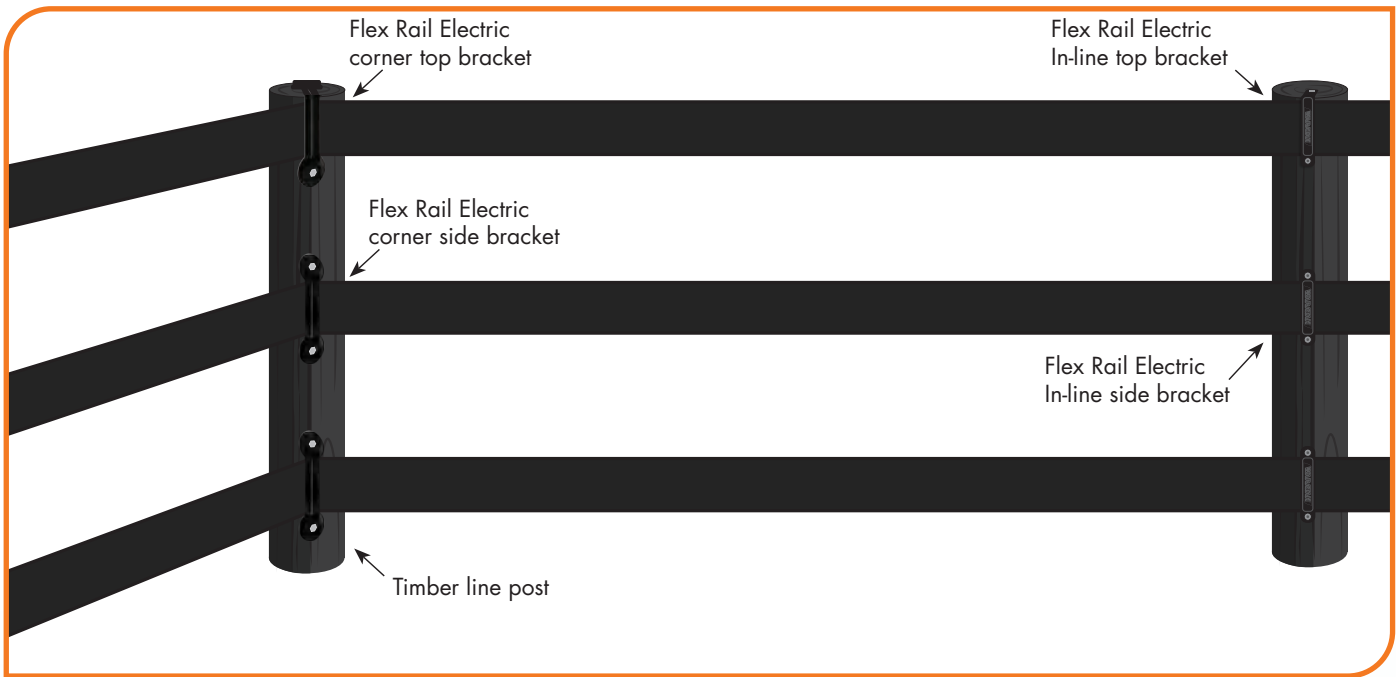

POSTS

3-6

WIRE

7-11

FLEX RAIL

12-21

ACCESSORIES

22-27

FLEX RAIL CORNER BRACKET FENCE DESIGN

INSTALLATION GUIDES

SCAN THE QR CODES TO DOWNLOAD WARATAH'S FLEX RAIL INSTALLATION GUIDES.



**ELECTRIC FLEX RAIL
INSTALLATION GUIDE**



**NON-ELECTRIC FLEX
RAIL INSTALLATION
GUIDE**





ACCESSORIES

- › **Save time and money by having the right tool for the job with Waratah®'s market-leading range of tools and accessories.**
- › **Whether you are constructing or maintaining your fence, all our equipment is designed to work together with the Waratah Fencing System™.**
- › **Waratah accessories simplify installation eliminating the need for machinery and extending the life of Longlife Blue® fence wire.**



EZYPIPE® STRAINER POST DRIVER

- › Essential for manual installation, the EzyPipe heavy duty, 19kg strainer post driver has a round profile to fit snugly over the EzyPipe posts.
- › Reinforced gusset handles for added strength.



THREE-WAY WIRE SPINNER

- › A multipurpose tool for safely spinning out plain wire without tangling or overrunning.
- › Operates in a stationary position.
- › Double cradle wire spinners also available.



WEDGELOCK® CLAMP - STANDARD

- › Hold prefabricated wire and netting in place while wizard wire strainers (hooked top and bottom of the clamp) evenly tension the wire.
- › Standard unit: available in 1.00m, 1.30m and 1.60m lengths to suit prefabricated fence heights.
- › Also available in Contractor size: 1.60m, 1.90, and 2.00m lengths to suit prefabricated fence heights.



WIZARD® WIRE STRAINER - STANDARD

- › Grips wire securely to efficiently tension plain and barbed fence wire.
- › Used with the Wedgelock® clamp to strain prefabricated fencing.
- › 1.80m long chain.

POSTS

3-6

WIRE

7-11

FLEX RAIL

12-21

ACCESSORIES

22-27



WIRE CUTTERS & FENCING PLIERS

- › Waratah wire cutters: a powerful cutter with ceramic precision cutting edges, designed for use with all fence wire types.
- › Waratah fencing pliers: a combination plier designed for gripping surfaces particularly suited to flat material and medium to hard wire.



RINGMASTER PNEUMATIC CLIP GUN

- › A fast, easy way to secure clips to fence wires, reducing physical effort and increasing the number of clips installed per hour.
- › Designed for use with 1.80mm Waratah Ringmaster Longlife Blue® clips (sold separately).



STAR® & MAXY® POST CAPS

- › High-visibility, UV resistant Star post caps make the posts safer and more visible.
- › White HDPE material for strength and fade resistance.
- › Pre-formed slots on white Star and MaxY post caps accommodate a wide range of electric accessories.



HEAVY DUTY PINLOCK INSULATOR

- › Twin pin system locks the insulator firmly in place.
- › The increased diameter front pin withstands higher wire pressure from stock impact.
- › Twin pin matched with the existing JiO® post holes for super fast installation/removal of wire under tension.



JiO® POST CLIP LONGLIFE BLUE®

- › Effectively secure fence wires to JiO posts, up to 20% faster than traditional clips.
- › Simple and easy to use - no tools required.
- › Made from Longlife Blue wire.



BARBED STAPLES LONGLIFE BLUE®

- › An ideal way to secure fence wire to timber posts, with Longlife Blue coating to prolong the life of your fence.
- › Provide greater holding pressure.
- › Available in wire diameters from 3.15mm to 4.00mm and in lengths from 32mm to 50mm.

POSTS

3-6

WIRE

7-11



RINGMASTER® LONGLIFE BLUE® CLIPS

- › Effectively secures all types of fence wire.
- › Recommended for use with the Waratah Ringmaster Pneumatic clip gun.
- › Made from 1.80mm Longlife Blue wire.



RING FASTENER LONGLIFE BLUE® CLIPS

- › Effectively secures all types of fence wire.
- › Recommended for use with a manual clip gun. **(Not for use with the Waratah Ringmaster Pneumatic clip gun.)**
- › Made from 2.00mm Longlife Blue wire.

FLEX RAIL

12-21

ACCESSORIES 22-27



STAY PINS

- › Conveniently pre-cut 30cm straight lengths to save time with no sharp ends for safe use.
- › Made from 10mm hot dipped galvanized rod.
- › Ideally suited for timber H box assemblies.



GRIPPLE® TL-300

- › Simple wire termination at strainer post.
- › Low profile design allows a safe and secure tension device suitable for equine fencing.
- › Eliminate the need for conventional tie-off knots around a strainer post.
- › Suitable for use with 2.00mm - 3.15mm wire.



GRIPPLE PLUS™

- › Gripple Plus wire joiners save time and effort when joining wires, tensioning or terminating wire at a strainer post.
- › The patented ceramic locking mechanism delivers a strong grip and can take higher loads
- › Available in small, medium and large.
- › Suitable for electric fencing applications.
- › Housing is die-cast zinc for superior corrosion protection.



GRIPPLE TENSIONING TOOLS

- › **CONTRACTOR TOOL**
Metal tool for use with all Gripple sizes makes light work of tensioning your wire by delivering a 10:1 mechanical advantage.
- › **STANDARD TOOL**
Available with the Gripple starter pack only - includes 50 Gripple Plus medium wire joiners. A cost saving of 25%.

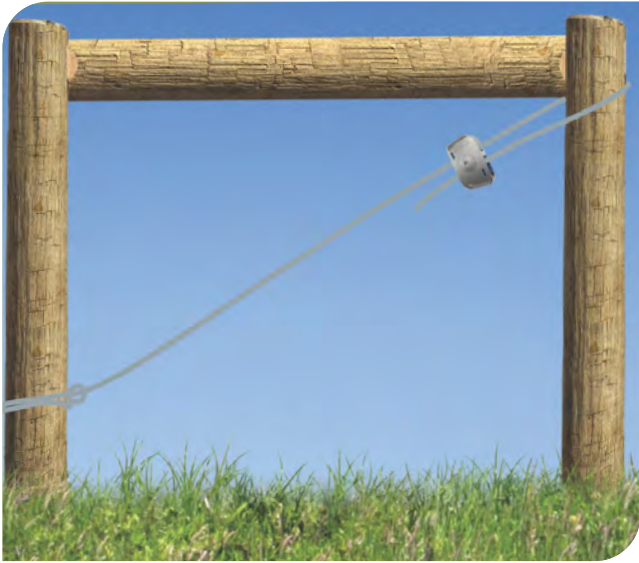

H-POST® / ANCHOR-FAST® KIT

- > Contains a 4mm x 5m heavy galvanized wire rope and Grippie Dynamic 4D.
- > Can be used as a wire brace or tie-back in multiple strainer post assembly setups.
- > Simple, one person assembly, no wire tying skills needed.
- > Up to 75% faster to install than traditional methods.



GRIPPIE® T-CLIP™ / T-CLIP LARGE

- > A great alternative to tying off wire around strainer posts. No need for knots, twisting or staples, saving both time & labour.
- > Allows consistent replication and is up to 5 times faster than a manual tie-off.
- > Recommended for round strainer posts.
- > T-Clip suitable for 1.80mm - 3.25mm wire.
- > T-Clip large suitable for 4.00mm plain wire.

ADVICE FOR FARMERS, FROM FARMERS

"The fencing we've done has been surprisingly tough and durable. I've seen a couple of our horses kick at the fence from time to time, and it's been able to withstand that pressure extremely well. We've got more fencing planned, and I'm confident it will be a good investment for our multi-purpose operation here."

- Martin Gostelow, NSW



POSTS

3-6

WIRE

7-11

FLEX RAIL

12-21

ACCESSORIES

22-27



FIRST - BECAUSE IT LASTS.



13 10 80



Website



Facebook



YouTube



Prepared by InfraBuild Wire Pty Limited ABN 59 000 010 873. Specifications or technical data referred to in this publication are subject to change, variation and/or improvement without notice and no warranty as to suitability for any use is made. Users of this publication should check all information to satisfy themselves as to its appropriateness and adequacy for their purposes. Unless required by law, the company accepts no responsibility for any loss, damage or consequence resulting from the use of this publication. Photographs are representative only of typical applications. This brochure is not an offer to trade and shall not form part of the trading terms in any transaction. © Copyright 2023 InfraBuild Wire Pty Limited. All Trademarks and Registered Trademarks referred to in this publication are the property of InfraBuild Wire Pty Limited, excluding Gripple, registered to Gripple Ltd. Waratah® guarantees that the Longlife® product range will provide best in class functionality unless abnormally severe corrosive conditions prevail, including use in regions within a few kilometres of surf beaches and polluting sources and where chemical contaminants (e.g. fertilisers) are in use. InfraBuild Wire Pty Limited, Ingall Street, Mayfield, NSW 2304.

Available at:

Visit waratahfencing.com.au or phone 13 10 80